

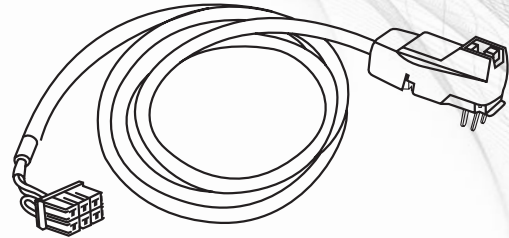

Accessory Power Cord Assembly for E-TAC II Packaged Terminal Air Conditioners

Models:

E2CORD-230V15A	E2CORD-265V15A
E2CORD-230V20A	E2CORD-265V20A
E2CORD-230V30A	E2CORD-265V30A



208/230v LCDI Power Cord (1)

POWER CONNECTION CHART

Unit Model	Electric Heater - Amp (KW)		
	15A (2.5KW)	20A (3.5KW)	30A (5.0KW)
230/208 VOLTS			
ETAC2-07HC230VA-A	E2CORD-230V15A	E2CORD-230V20A	Not Available *
ETAC2-09HC230VA-A			
ETAC2-12HC230VA-A			E2CORD-230V30A
ETAC2-15HC230VA-A			Not Available *
ETAC2-07HP230VA-A			E2CORD-230V30A
ETAC2-09HP230VA-A			
ETAC2-12HP230VA-A			
ETAC2-15HP230VA-A			
265 VOLTS			
ETAC2-07HC265VA-A	E2CORD-265V15A	E2CORD-265V20A	Not Available
ETAC2-09HC265VA-A			
ETAC2-12HC265VA-A			E2CORD-265V30A
ETAC2-15HC265VA-A			Not Available
ETAC2-07HP265VA-A			E2CORD-265V30A
ETAC2-09HP265VA-A			
ETAC2-12HP265VA-A			
ETAC2-15HP265VA-A			

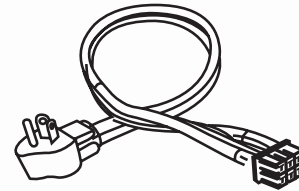

265v Power Cord (1)



Wire Clamp (1)



Screw (1)

* Using 30A on these units could result in damage to your unit.

* Only one power cord provided depending on kit ordered.

SAFETY PRECAUTIONS – Please read the following before installation.



This is the safety alert symbol. It is used to alert you to potential personal injury hazards. Obey all safety messages that follow this symbol to avoid possible injury or death.

WARNING

This mark indicates procedures which, if improperly performed, might lead to the death or serious injury of the user.

CAUTION

This mark indicates procedures which, if improperly performed, might possibly result in personal harm to the user, or damage to property.

NOTICE

Notice is used to highlight suggestions which will result in enhanced installation, reliability and operation.

WARNING – Electrical shock hazard and/or unit operation and damage hazard

Failure to follow this warning could result in personal injury or death and/or unit operation and damage. Installing and servicing air conditioning equipment can be hazardous due to system pressures and electrical components. Only trained and qualified personnel should install or service air conditioning equipment. When working on air conditioning equipment, observe the precautions provided in literature, tags and labels attached to the unit.

1. Follow the National Electrical Code (NEC) or local codes and ordinances.
2. For personal safety, this unit **MUST BE** properly grounded.
3. Protective devices (fuses or circuit breakers) acceptable for unit installations are specified on the nameplate of each unit.
4. **DO NOT** use an extension cord with this unit.

INSTALLATION

⚠ WARNING – Disconnect, lockout and tag all electrical power devices to unit including disconnects, fuses and circuit breakers.

1. Remove front panel.

- Pull out at the bottom to release it from the tabs (1).
- Then lift up (2).

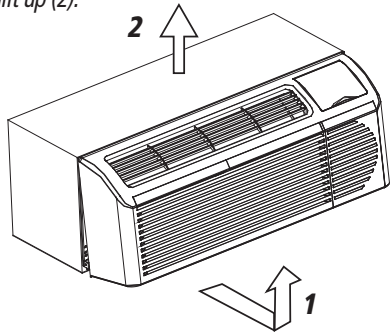

2. Remove junction box.

- Remove junction box cover by removing three screws from front (save these for later).
- Remove junction box by taking out top, rear and side screws (save these for later).

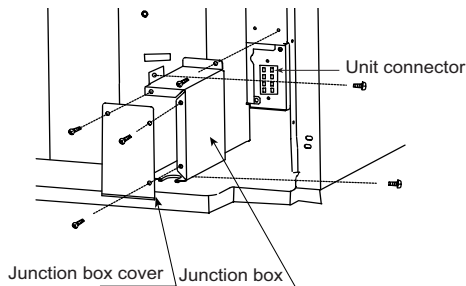

3. Connect power cord connector to unit connector.

- Units must be installed using the appropriate power cord kit. See Power Connection Chart on page 1.

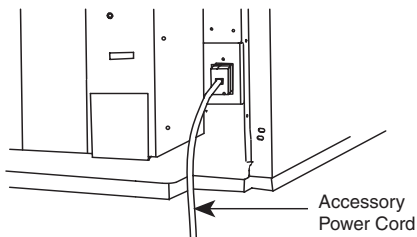

4. Re-install junction box and cover. Secure power cord.

- Re-install junction box using parts saved in Step 2.b.
- Use wire clamp to secure power cord to basepan with screw provided.
- Replace junction box cover using parts saved in Step 2.a.

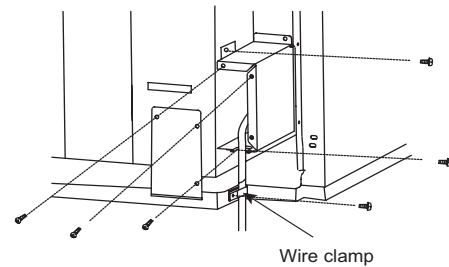

5. Replace front panel.

- Place tabs over top rail (1).
- Push inward at bottom until panel snaps into place (2).

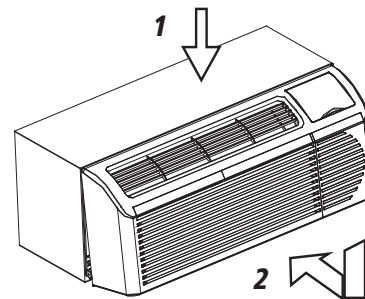

6. Plug unit in and turn power on.

For complete instructions on these and other functions, as well as important safety information, see the ETACII Owners Manual.

For more information, visit GreeComfort.com.



66129920735

